

SCHLAGE

Keypad Locks

User Guide

LLEGIÓN



BE365



FE575/FE595

PLEASE KEEP THIS GUIDE
You will need these codes to operate
your lock!

CONSERVE ESTA GUÍA
¡Necesitará estos códigos para operar
la cerradura!

VEUILLEZ CONSERVERCE GUIDE
Vous aurez besoin de ces codes pour
faire fonctionner la serrure!



Keypad Locks User's Guide

Contents

Warranty.....	2	Schlage Button Signals.....	10
Lock Parts	4	Codes.....	10
Keypad Deadbolt.....	4	Default Code Locations.....	10
Keypad Lever.....	5	Basic Controls.....	11
Keypad Deadbolt	6	Enhanced Controls.....	12
Locking and Unlocking.....	6	Record Your Codes	13
Changing the Battery.....	6	User Codes.....	13
Key Override.....	7	Troubleshooting	14
Lock Override.....	7	Restore Factory Settings.....	15
Keypad Locks	8		
Locking and Unlocking.....	8		
Key Override.....	8		
Changing the Battery.....	9		
Programming Guide	10		

Warranty

Lifetime Limited Mechanical and Finish Warranty and 1-Year Limited Electronics Warranty
Subject to the terms and conditions of the warranty, Schlage extends a lifetime limited mechanical and finish warranty and a one-year limited electronics warranty to the original consumer user ("Original User") of our Schlage brand product ("Product") against defects in material and workmanship, as long as the Original User occupies the residential premises upon which the Product was originally installed. See answers.schlage.com for specific warranty details and limitations, or contact Schlage Customer Service at (888) 805-9837 in the U.S., 800-997-4734 in Canada or 018005067866 in Mexico for assistance.

Register your Product



Document your purchase and register your warranty at RegisterMySchlage.com

» PLEASE KEEP THIS GUIDE

This guide contains important information about your lock!

- Default User Codes and Programming Code are located on the sticker on the back of this guide! You will need these if you ever need to reset your lock back to factory default settings!
- The sticker also contains your serial number, which may be needed for warranty and customer service support.
- Instructions for adding and deleting User Codes, changing the lock behavior, troubleshooting, customer service and more are explained in this guide!

» WHY DO I NEED KEYS IF THIS IS A KEYLESS LOCK?

Good question! In the event that the battery is dead, or no User Code is known, you can use the key to gain access by employing the emergency key override.



**UNLOCK
YOUR SOLUTION**

Browse to answers.schlage.com and click on **Electronic Keypad Locks** in the menu on the right side for videos, troubleshooting, FAQ and more.

Questions about your
new keypad lock?

Please don't return it to the store!

Let us help you first!

Need Help?



For technical documents and videos, visit answers.schlage.com



U.S.A.: 888-805-9837
Canada: 800-997-4734
Mexico: 018005067866

LOCK PARTS

Keypad Deadbolt

Model BE365

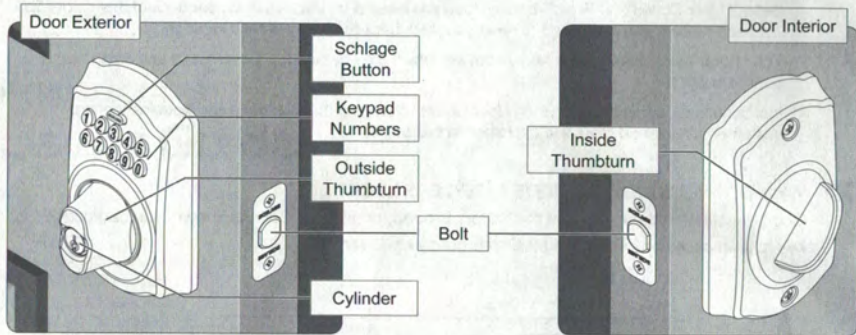

Keypad

- Used to enter codes for programming and unlocking. See **Programming Guide** on page 10 and **Locking and Unlocking** on page 6 for more information.

Outside Thumbturn

- Used to unlock the lock after a valid User Code has been entered, or to lock the lock after the Schlage button has been pressed.

Cylinder

- Used only in emergency situations to unlock the lock. See **Key Override** on page 7.

Inside Thumbturn

- Used to lock or unlock the lock.

Keypad Lever

Models FE575 (Auto Lock) and FE595 (Flex Lock)

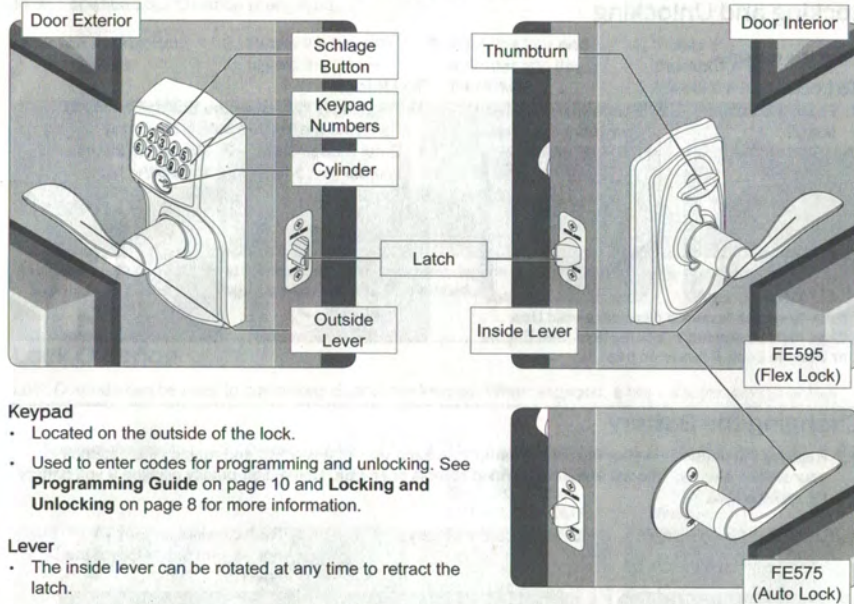

Keypad

- Located on the outside of the lock.
- Used to enter codes for programming and unlocking. See **Programming Guide** on page 10 and **Locking and Unlocking** on page 8 for more information.

Lever

- The inside lever can be rotated at any time to retract the latch.
- The outside lever can be rotated at any time, but will only retract the latch when the lock is unlocked.

Cylinder

- Located on the outside of the lock.
- Used only in emergency situations to unlock the lock. See **Key Override** on page 8.

Thumbturn

- FE595 ONLY: Used to put the lock in a locked or unlocked state.

KEYPAD DEADBOLT

MODEL BE365

Locking and Unlocking

From the outside:

To Lock

1. Press the Schlage button.*
2. Rotate the thumbturn away from the hinges.



* If the Turn Lock feature is disabled, a valid User Code must be entered to lock the door. See **Enable or Disable Lock & Leave** on page 12.

To Unlock

▶ If lighting is low, press the Schlage button to illuminate the keypad before beginning.

1. Enter a User Code
2. Rotate the thumbturn into the keypad.



Changing the Battery

▶▶ Replace the batteries in your lock at the same time each year that you test and replace the batteries in your smoke alarms. This will ensure continued reliable operation. Use a high-quality alkaline 9 volt battery for replacement.

1. Remove the inside cover.
2. Replace the battery.

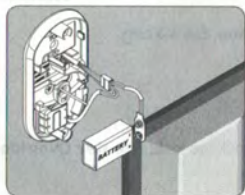
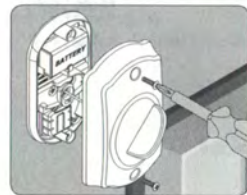

3. Re-tuck wires so they will not be crimped. Replace the cover.

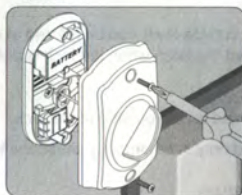

Key Override

Key Override can be used to gain access when the battery is completely dead, when no valid User Code is known or when Lock Override is engaged.

1. Insert the key into the cylinder.
2. Rotate the key 90° toward the hinges.
3. Push the key and cylinder into the thumbturn.
4. Rotate the thumbturn 90° toward the hinges.†



† Reverse steps to relock. Hold the thumbturn still while removing the key. See **Changing the Battery** on page 6 or **Restore Factory Settings** on page 15 for more information.

Lock Override

Lock Override can be used to completely disable the keypad. When engaged, a key must be used to unlock the lock.

1. Remove the inside cover.
2. Disconnect and remove the battery.
3. Use a small flathead screwdriver to rotate the lock override screw to **LOCKOUT**.
4. Re-tuck wires so they will not be crimped. Replace the cover.

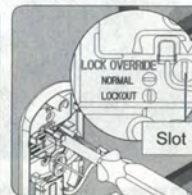
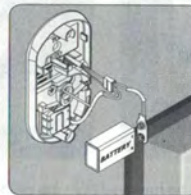
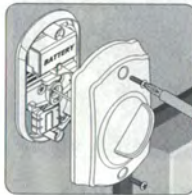

Lithium Batteries?



Lithium batteries may have a longer life, but when they begin to fail, they fail quickly. We don't recommend them because they don't give you a lot of time to change your batteries before the lock is completely dead.

ENGLISH

KEYPAD LOCKS

MODELS FE575— AUTO LOCK AND FE595— FLEX LOCK

Locking and Unlocking

Keypad locks are always locked from the outside, by default. Only the FE595 can be set to unlocked.

To Temporarily Unlock

» If lighting is low, press the Schlage button to illuminate the keypad before beginning.

1. Enter a User Code into the keypad.
2. Rotate the lever to open the door. Door will automatically re-lock.

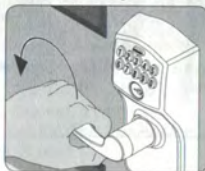
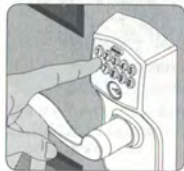

To Set to Unlocked (FE595 Only)

1. Rotate the inside thumbturn to the vertical position.*
2. Rotate the thumbturn back to the horizontal position to re-lock.



* No User Code is required to open the door when the lock is set to unlocked.

Key Override

Key Override can be used when the battery is completely dead, or when no valid User Code is known.

1. Insert key.
2. Rotate key 270° to unlock.
3. Rotate knob/lever to open door.*

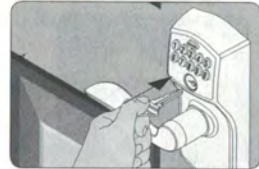

* Rotate the key back to starting position to relock. The key cannot be removed from the cylinder while the lock is unlocked. See **Changing the Battery** on page 9 or **Restore Factory Settings** on page 15 for more information.

Changing the Battery

» Replace the batteries in your lock at the same time each year that you test and replace the batteries in your smoke alarms. This will ensure continued reliable operation. Use a high-quality alkaline 9 volt battery for replacement.

FE595

1. Remove the inside cover.
2. Replace the battery.
3. Replace the cover.

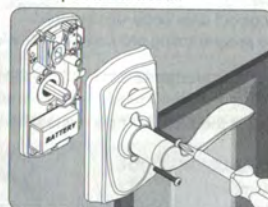
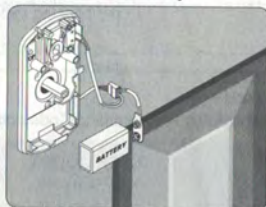
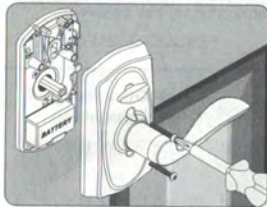

FE575

1. Remove the lock from the door.
2. Open the battery compartment and replace the battery.
3. Reinstall the lock on the door.

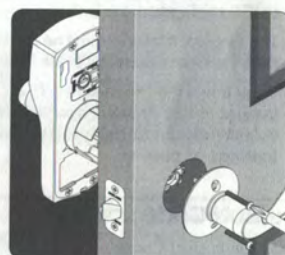
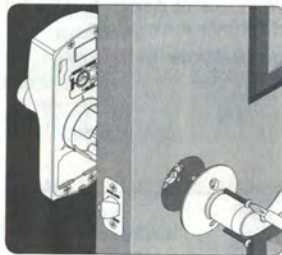

What is the difference between the Auto Lock and the Flex Lock?



The Auto Lock (FE575) is always locked from the outside. The Flex Lock (FE595) is normally locked from the outside, but can be set to unlocked by putting the thumbturn in the vertical position.

Lithium Batteries?



Lithium batteries may have a longer life, but when they begin to fail, they fail quickly. We don't recommend them because they don't give you a lot of time to change your batteries before the lock is completely dead.

PROGRAMMING GUIDE

Schlage Button Signals

The color of the Schlage button indicates the status of the lock.

Orange

- the lock is in programming mode

Green

- a correct user code was entered
- the programming process is complete

Red

- an incorrect user code was entered
- there was an error in programming
- low batteries
- red blinking indicates critically low battery

Codes

Control of the lock is simply managed via a six-digit Programming Code and four-digit User Codes.

PROGRAMMING CODE

(Six Numbers)

- The lock comes preset with one unique default Programming Code. It can be found on the stickers, one on the back of the keypad assembly and one on the front of this User Guide.
- Used to put the lock in programming mode.
- DOES NOT unlock the lock.
- The first four numbers must be different from all of the User Codes currently in the lock.
- If you forget the Programming Code, you can reset the lock to factory settings, which restores the default Programming Code. See **Restore Factory Settings** on page 15.

USER CODES

(Four Numbers)

- The lock comes preset with two unique default User Codes. They may be found on the stickers, one on the back of the keypad assembly and one on the front of this User Guide.
- Used to unlock the lock.
- These four numbers must be different from the first four numbers of the Programming Code.
- Up to 19 possible User Codes can be stored in the lock at one time.

Default Code Locations

The Default User Codes and Programming Code are located in two places:

Back of the Keypad

- You must remove the Keypad from the door to see this sticker.

Front of this User Guide



Basic Controls

- Write your programming code here for easy access. Also see **Record Your Codes** on page 13 for space to record User Codes.

PROGRAMMING CODE					

- If you make a mistake during programming, press the Schlage button repeatedly until the keypad lights blue. Then start over.

ADDING USER CODES*

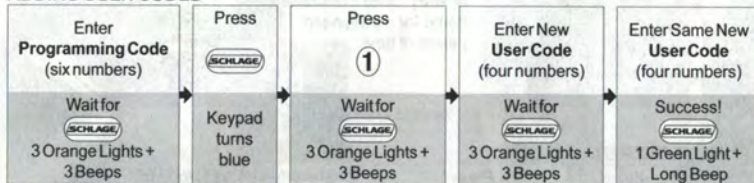

* These four numbers must be different from the first four numbers of the Programming Code.

DELETING USER CODES

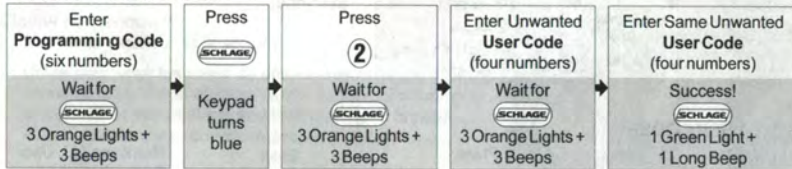

CHANGING THE PROGRAMMING CODE*

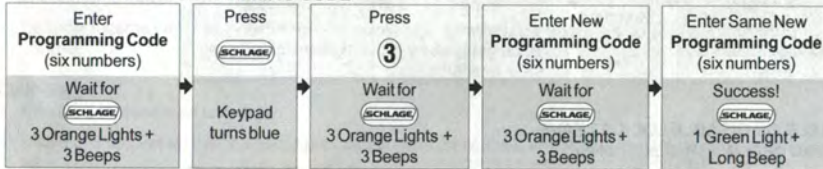

* The first four numbers must be different from all of the User Codes currently in the lock.

Want to see a video?



Browse to answers.schlage.com and search on "How to Program Keypad Lock" for a video. Other videos and information are also available.

Enhanced Controls

Schlage's keypad locks were designed with added features that allow you to adapt the lock to your needs. Additional features that you can choose to use include:

ENABLE VACATION MODE

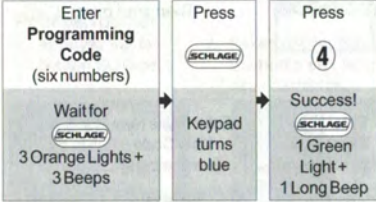

When enabled, no User Codes will unlock the door, preventing any unauthorized attempts of entry when no one is home for a prolonged period of time.

DISABLE VACATION MODE

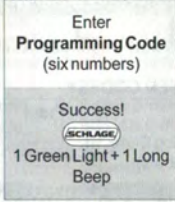

ENABLE OR DISABLE BEEPER

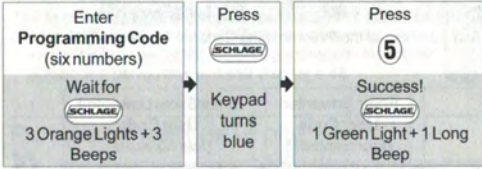

The beeper can be turned off if desired. Beeps will still sound during programming. The beeper may not be audible to everyone.

DELETE ALL USER CODES

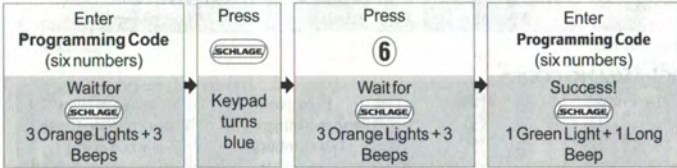

Removes ALL User Codes from the lock.

ENABLE OR DISABLE LOCK & LEAVE KEYPAD DEADBOLT (BE365) ONLY

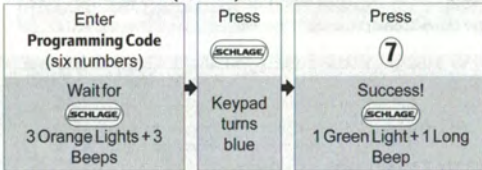

Enabled by default. When enabled, the deadbolt can be locked from the outside by pressing the Schlage button and rotating the thumbturn. When disabled, a User Code must be entered before rotating the thumbturn. Disabling this feature keeps an unauthorized person from locking the door from the outside.

RECORD YOUR CODES

KEYPAD WEAR

Consider changing your codes on a periodic basis so buttons wear evenly.

PROGRAMMING CODE

--	--	--	--	--	--

User Codes



Up to 19 User Codes can be stored in the lock at one time.

NAME
EXAMPLE: JOHN SMITH

USER CODE				
1	2	3	4	

TROUBLESHOOTING

Browse to answers.schlage.com and click on **Electronic Keypad Locks** in the menu on the right side for videos, troubleshooting, FAQ and more.

Lock Issue	Beeps*	Lights	Solution
KEYPAD DEADBOLT ONLY I can unlock my deadbolt by simply pushing the Schlage button. I don't need a code. After pushing  and rotating thumbturn, the deadbolt does not extend. After entering my User Code, the lock flashes green, but I cannot unlock the lock. Outside thumbturn does not freely spin after deadbolt is thrown.	1 High	Green Blinking	Your lock has been installed incorrectly and is not secure. Repeat the installation process. Ensure the cam and bolt positions are correct, as referenced in the installation instructions. Browse to answers.schlage.com and search on "Installing BE365" for a video.
	None	None	Lock and Leave feature is disabled. See Enable or Disable Lock & Leave on page 12.
	1 High	Green Blinking	Lock Override is enabled and should be disabled. See Lock Override on page 7.
	None	None	Lock is malfunctioning. Disable the keypad by enabling Lock Override. See Lock Override on page 7. Call Customer Service.
I forgot my Programming Code.	None	None	Check the front of this guide or the back of the keypad assembly for the default Programming Code. If needed, restore lock to factory settings. See Restore Factory Settings on page 15.
I need to delete a User Code that I don't remember.	None	None	Delete all User Codes. Then add all needed User Codes back into the lock. See Programming Guide on page 10.
User Code does not unlock lock.	2	Red	User Code entered is not a valid User Code.
	1 High, 1 Low	Green then Red	Vacation Mode is enabled. See Disable Vacation Mode on page 12.
 does not light when numbers are pressed.	None	None	Too many incorrect User Codes have been entered. Wait 30 seconds and try again. If keypad does not respond after 30 seconds, then replace battery. See Changing the Battery on page 6 for Keypad Deadbolt or Changing the Battery on page 9 for Keypad Lock.
There is a delay before unlock after a valid User Code is entered.	High/Low, then 1	Red then Green	Battery is low and should be replaced. See Changing the Battery on page 6 for Keypad Deadbolt or Changing the Battery on page 9 for Keypad Lock.
 blinking red but no codes have been entered.	None	Quick Red Blinking	Battery is dead and MUST be replaced. See Changing the Battery on page 6 for Keypad Deadbolt or Changing the Battery on page 9 for Keypad Lock.

Lock Issue	Beeps*	Lights	Solution
Cannot add a new User Code.	High/Low	Red	19 User Codes already exist. Delete a User Code before adding a new one. See Deleting User Codes on page 11.
	2	Red	Second User Code entered did not match first User Code entered. See Adding User Codes* on page 11.
			The User Code matches the first four digits of the existing Programming Code.
Cannot delete a User Code.	2	Red	Second User Code entered did not match first User Code entered.
Cannot change Programming Code.	2	Red	Second Programming Code entered did not match first Programming Code entered. See Changing the Programming Code* on page 11.
			First four digits of new Programming Code match an existing User Code.
Cannot delete all User Codes.	2	Red	Programming Code entered second time is incorrect.
Lock will not stay in programming mode.	2	Red	Any key other than  was pressed immediately after programming mode was entered.
			An incorrect entry was made during the programming process.

* Number of beeps if beeper is turned on.

Restore Factory Settings

If you lose or forget your Programming Code, you can restore the factory settings, which will restore the default Programming code.

1. Disconnect the battery.
2. Press and release the Schlage button.
3. The following steps must occur within 10 seconds:
 - a. Reconnect the battery. The Schlage button will light green for one second.
 - b. Then, press and hold the Schlage button until it lights green and the lock beeps.
4. Try entering one of the default User Codes. If it does not unlock the lock, start over at step 2.

Once you've done this, you can change the programming code to a personalized number. See **Changing the Programming Code*** on page 11.

⚠ WARNING ⚠

Locate the default Programming and User Codes on the front of this guide or the back of the Keypad Assembly before beginning! Default Programming and User Codes will be restored. All existing User Codes and current Programming Code will be erased.

CUSTOMER SERVICE CANNOT RETRIEVE LOST DEFAULT CODES! DO NOT RESTORE FACTORY SETTINGS UNLESS YOU CAN LOCATE THE DEFAULT CODES.